

www.cela.it





30,20 m



16,00 m



260 KG



-7,00 m



225 kg



90°+90°

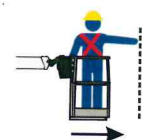

28,20 m

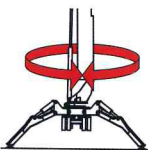

360°



ELECTRONIC
+ RADIO

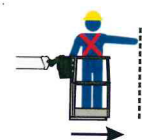

15,50 m

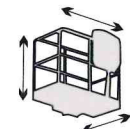

ALUMINIUM
1,8X0,7X1,1

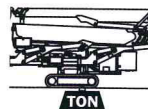

5,0 T

DT30 SPYDER

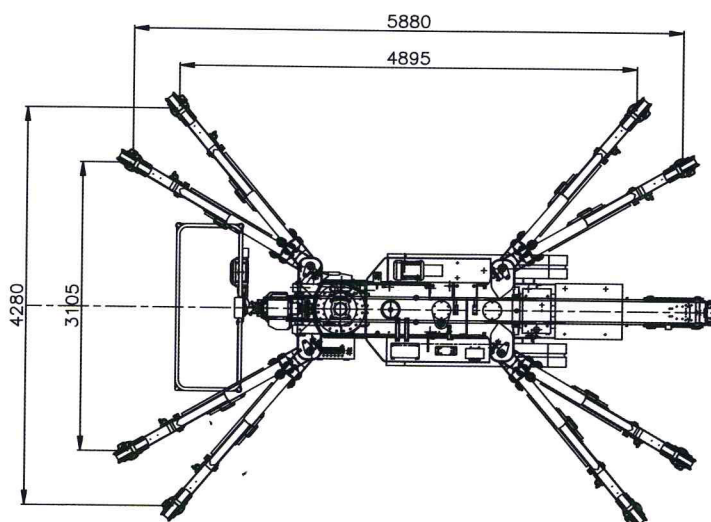
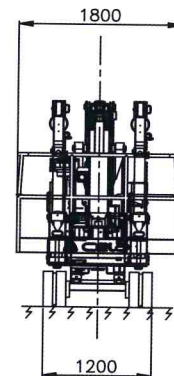
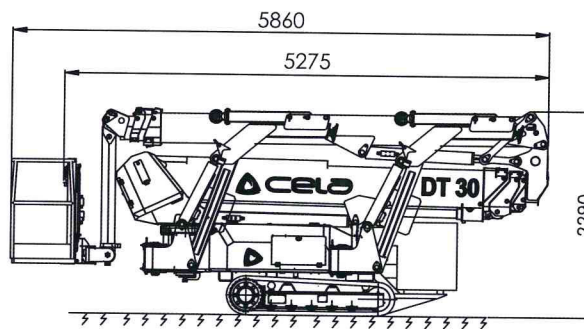
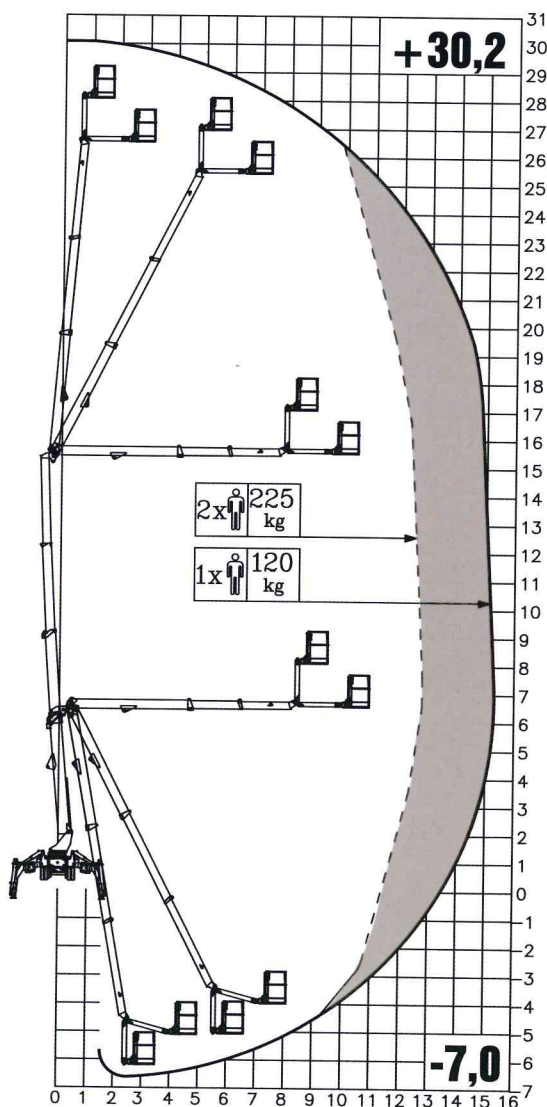

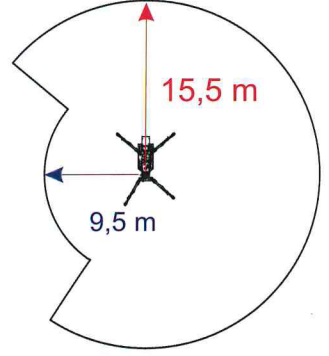
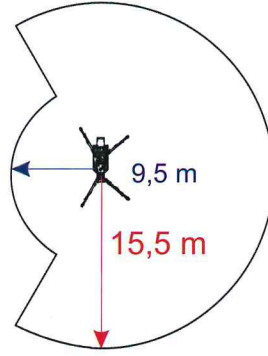
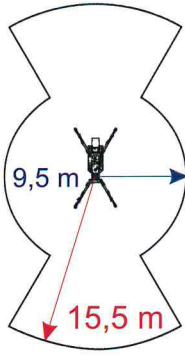
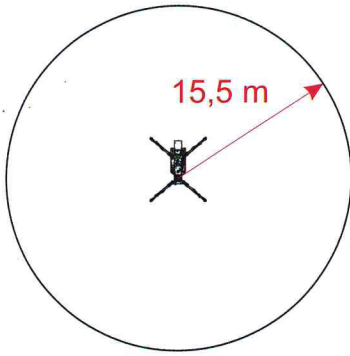

Cela
Industry

Passiamo sopra ogni cosa
We fly all over



**16 mts up and
15,5 mts over:
never so high**

Sottosopra
Downunder

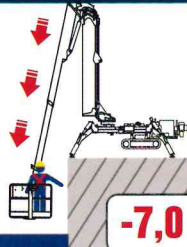

-7,0 m

Tutto in uno
All in one

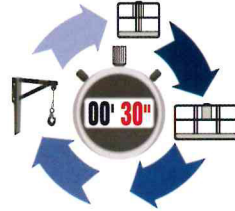

Atterriamo ovunque
We land everywhere

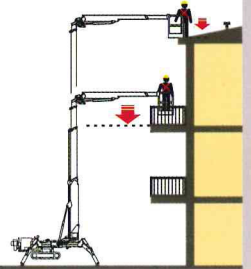

Come un ascensore
Like an elevator

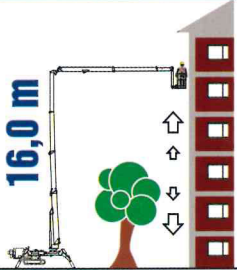

16,0 m

Dolci e Veloci
Smooth and fast

**Comandi a controllo elettronico,
manovre multiple simultanee**
Electronic controls, multi syncro manoeuvres

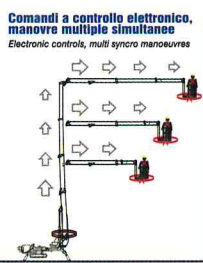

Auto Stabilizzazione
Automatic Stabilization

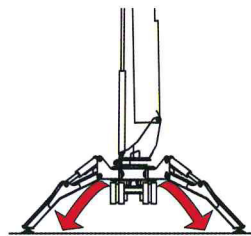

Siamo i più forti
We are the strongest

225 kg



260 kg



Doppia Omologazione
Crane/Platform
CE Certificate

Non ti facciamo girare la testa
We don't drive (your head) crazy

90° + 90°

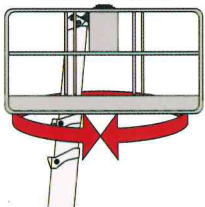

Sempre al tuo fianco
Always with you

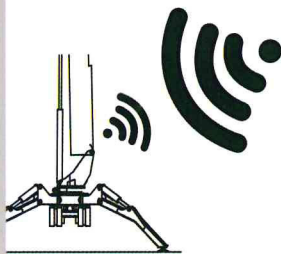

Autocaricamento
No ramps needed

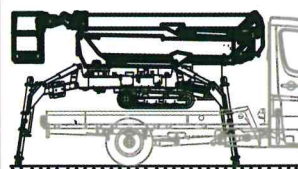

www.cela.it



DT30
SPYDER

