





28,20 m



16,00 m



390 KG

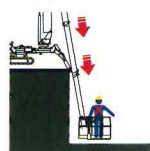

-6,00 m



350 kg



90°+90°



26,20 m

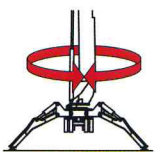

565°



ELECTRONIC  
+ RADIO



14,00 m

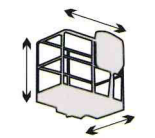

ALUMINIUM  
1,8X0,7X1,1

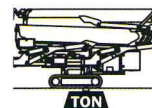

4,9 T

# DT28 SPYDER

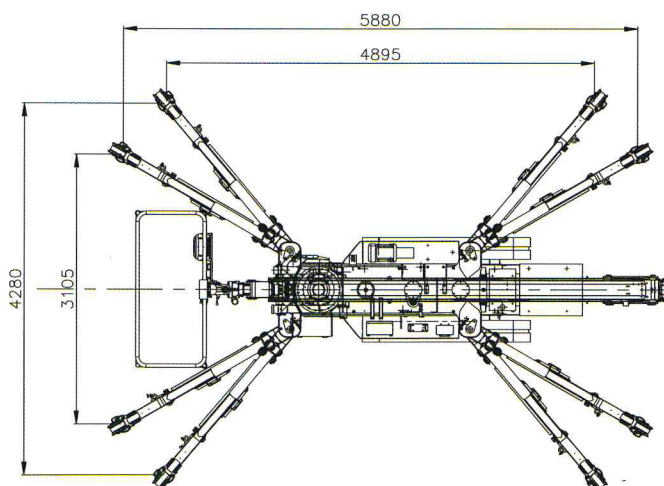
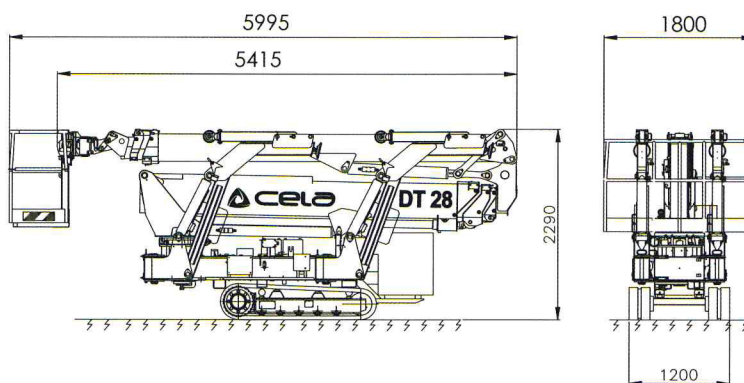
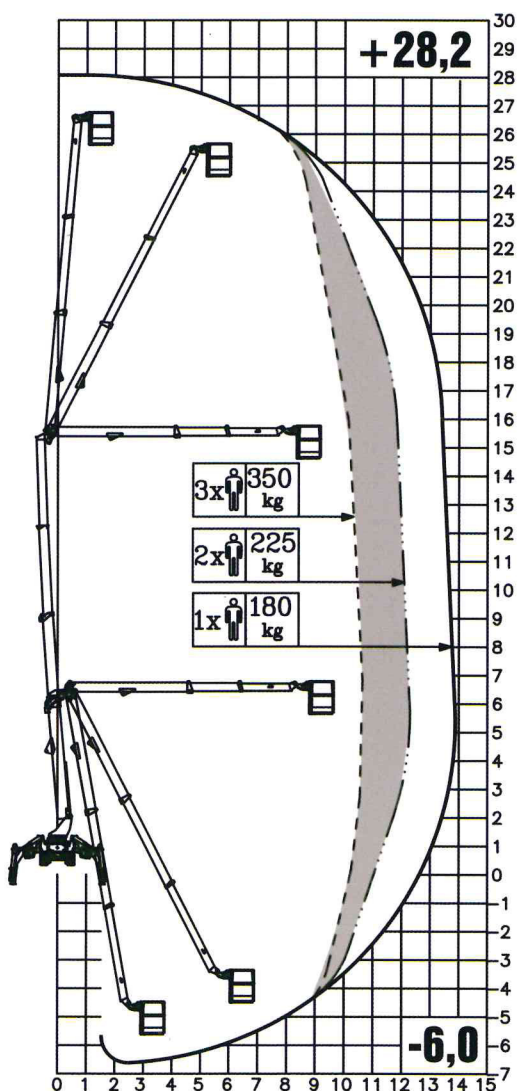

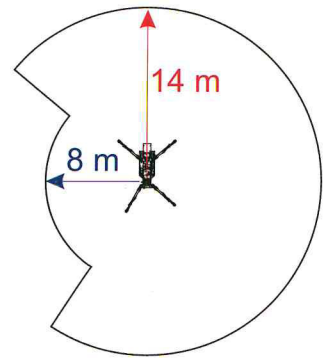
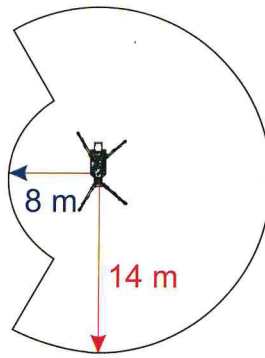
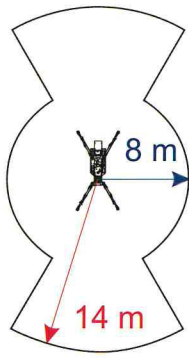
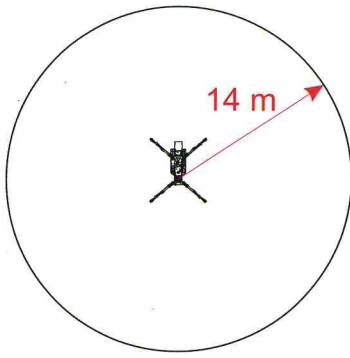

**CELA**  
industry

**Passiamo sopra ogni cosa**  
We fly all over

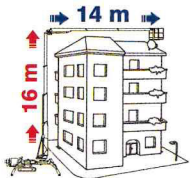

**16 mts up and  
14 mts over:  
never so high**

**Sottosopra**  
Downunder

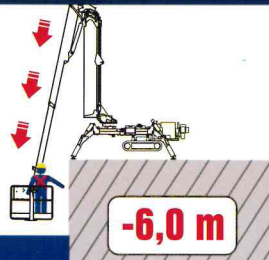

**-6,0 m**

**Tutto in uno**  
All in one

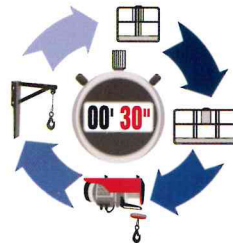

**Atterriamo ovunque**  
We land everywhere

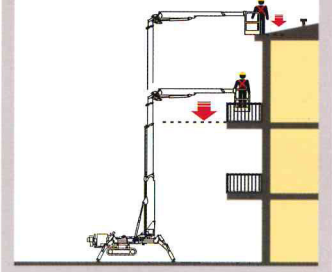

**Come un ascensore**  
Like an elevator

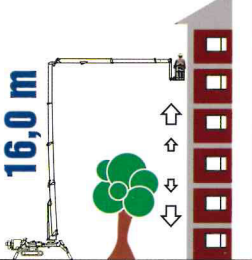

**16,0 m**

**Dolci e Veloci**  
Smooth and fast

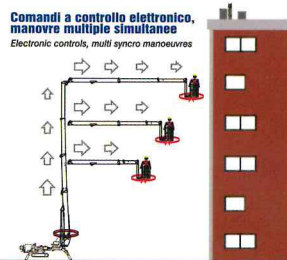

**Comandi a controllo elettronico,  
manovre multiple simultanee**  
*Electronic controls, multi syncro manoeuvres*

**Auto Stabilizzazione**  
Automatic Stabilization

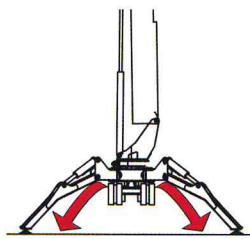

**Siamo i più forti**  
We are the strongest

**350 kg**

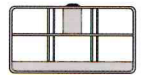

**390 kg**



**Portata Utile - Capacity**

**Non ti facciamo girare la testa**  
We don't drive (your head) crazy

**90° + 90°**

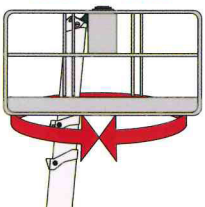

**Sempre al tuo fianco**  
Always with you

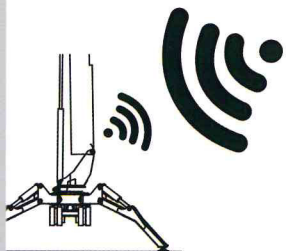

**Autocaricamento**  
No ramps needed

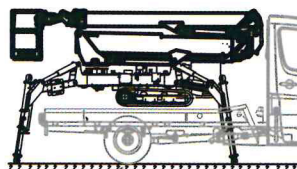

[www.cela.it](http://www.cela.it)

» **DT28**  
SPYDER

