

DT15
SPYDER

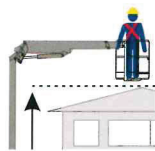



15,00 m



8,00 m



ELECTRONIC
+ RADIO

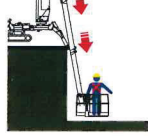

-1,50 m



200 kg

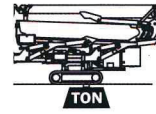

1,55 T



13,00 m

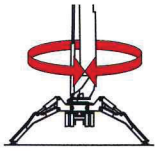

720°

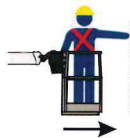

7,50 m

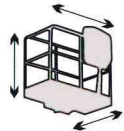

ALUMINIUM
0,7X0,7X1,1
1,4X0,7X1,1

DT15 SPYDER

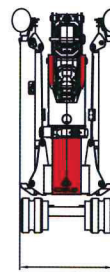
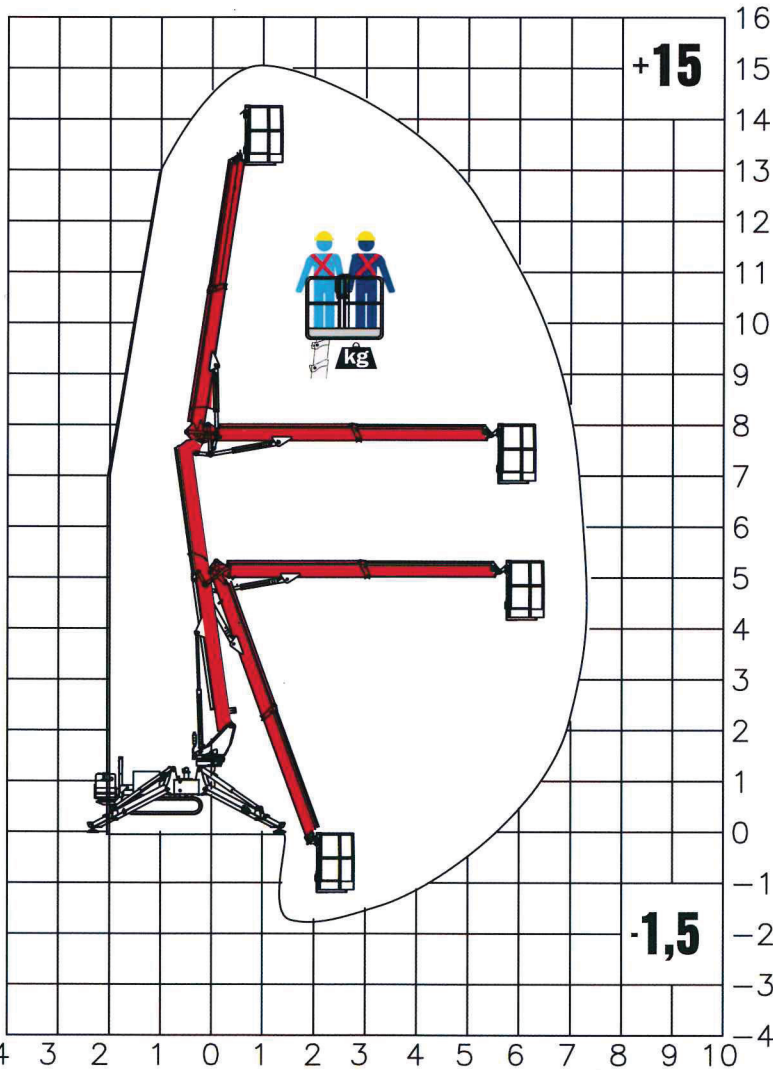

800

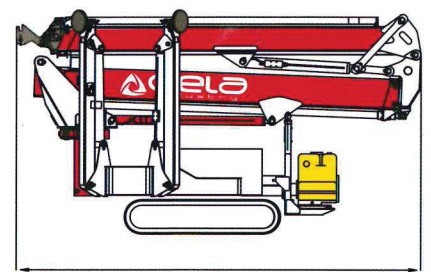

3595

4250

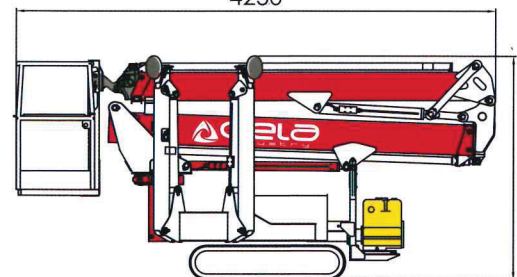

1950

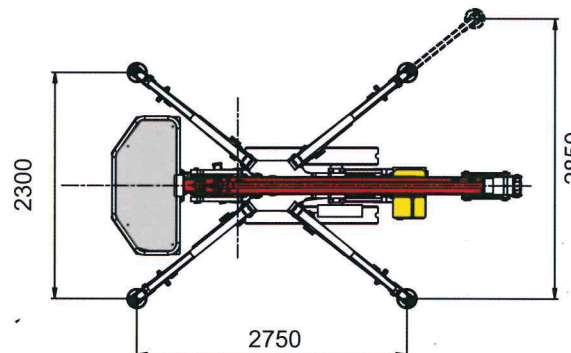

2300

2750

2850

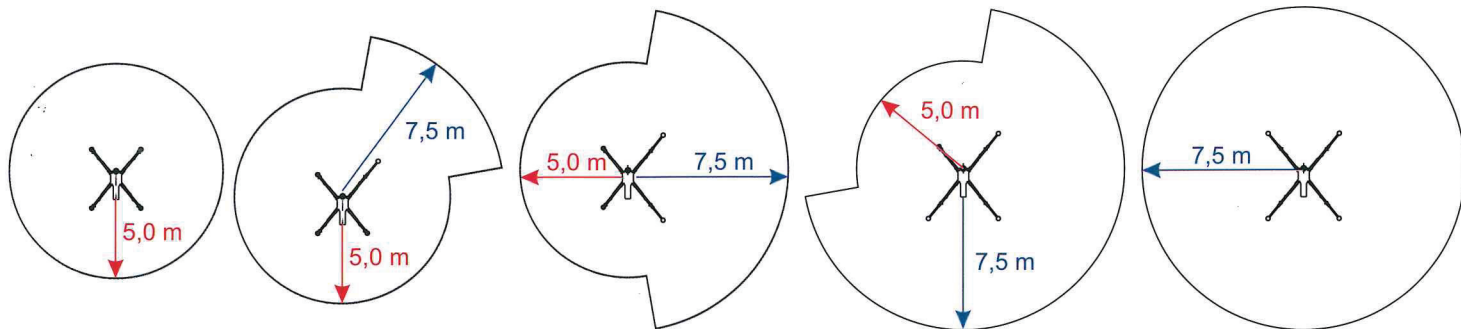

CELA
industry

Passiamo sopra ogni cosa
We fly all over



**8 mts up and
7,5 mts over:
never so high**

Sottosopra
Downunder

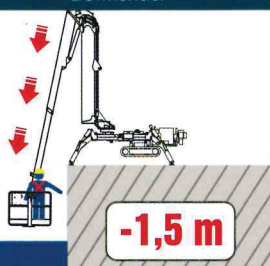

-1,5 m

Tutto in uno
All in one

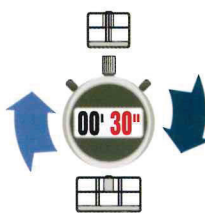

Atterriamo ovunque
We land everywhere

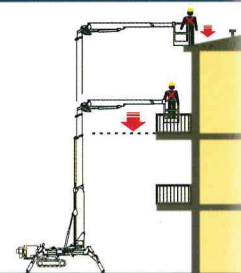

Come un ascensore
Like an elevator

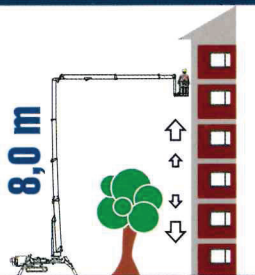

Dolci e Veloci
Smooth and fast

**Comandi a controllo elettronico,
manovre multiple simultanee**
Electronic controls, multi synchro manoeuvres

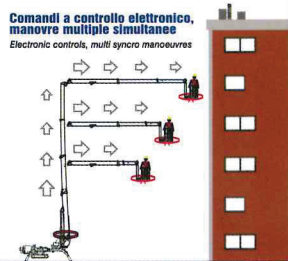

Auto Stabilizzazione
Automatic Stabilization

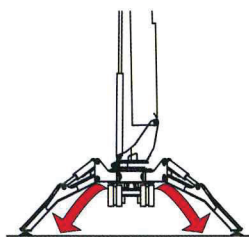

Siamo i più forti
We are the strongest ones

200 kg

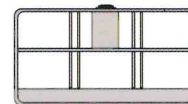

Portata Utile - Capacity

Sempre al tuo fianco
Always with you

