

[www.cela.it](http://www.cela.it)

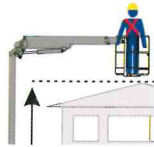



28,20 m



16,00 m



390 kg

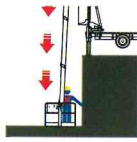

-6,00 m



350 kg

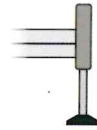

H+H



26,20 m

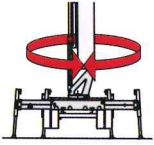

1440°



90°+90°

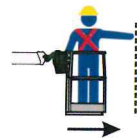

14,00 m

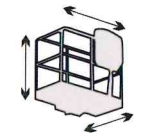

ALUMINIUM  
1,8X0,7X1,1



ELECTRONIC

# DT28

MIN. PTT 6,0t

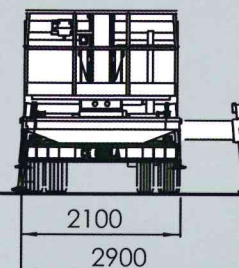
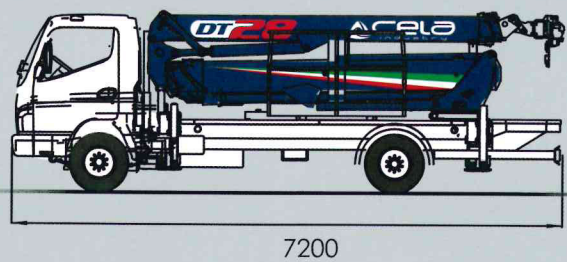
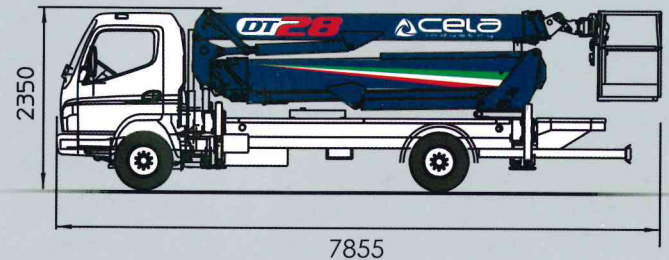
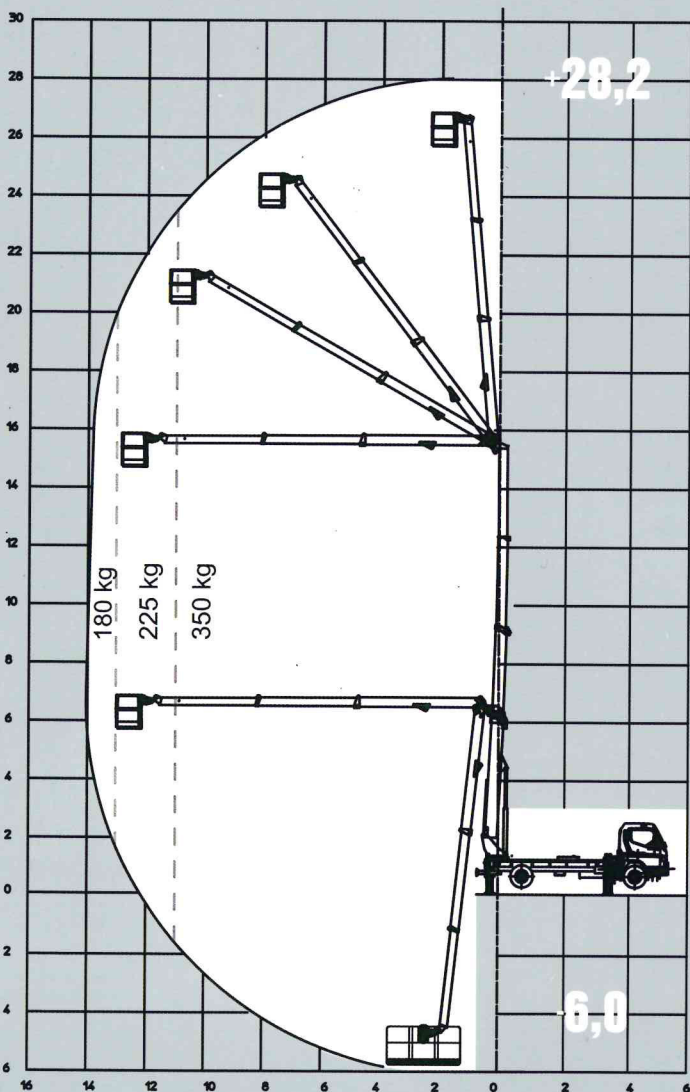

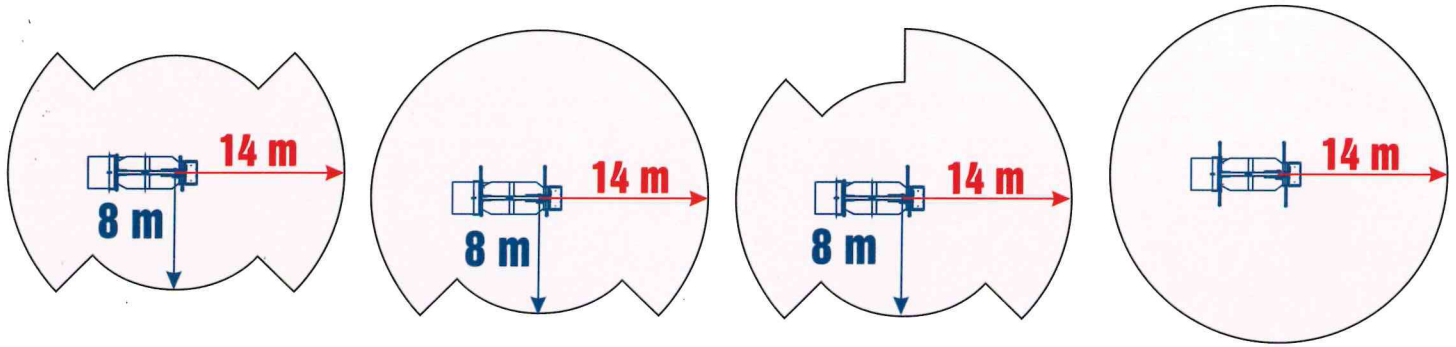

**La piattaforma invisibile**  
The invisible boom



**Passiamo sopra ogni cosa**  
We fly all over

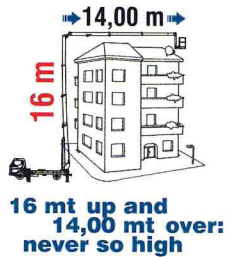

**Sottosopra**  
Downunder

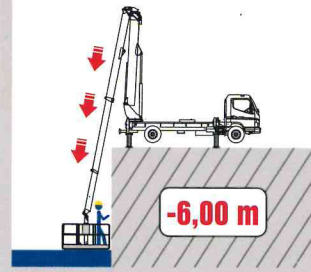

**Tutto in uno**  
All in one

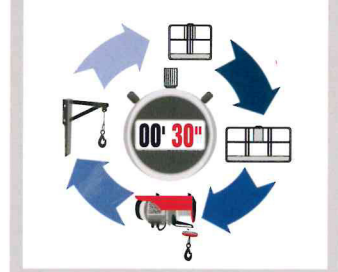

**Atterriamo ovunque**  
We land everywhere

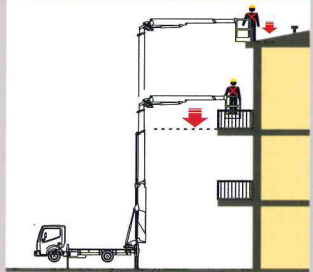

**Come un ascensore**  
Like an elevator

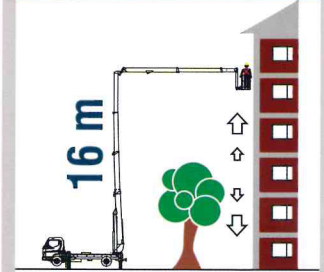

**Dolci e Veloci**  
Smooth and fast

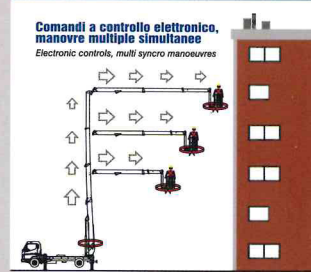

**Auto Stabilizzazione**  
Automatic Stabilization

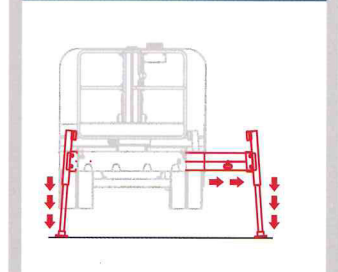

**Non ti facciamo girare la testa**  
We don't drive (your head) crazy

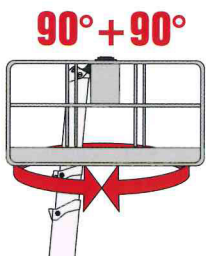

**Siamo i più forti**  
We are the strongest ones



**Sempre al tuo fianco**  
Always with you

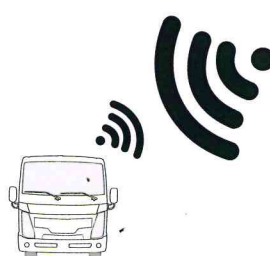

**Ti spianiamo la strada**  
We pave your road

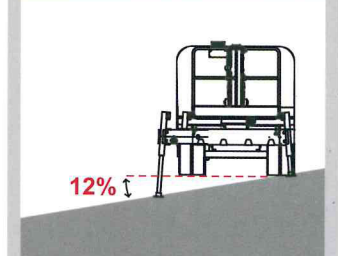

# DT28

28,20

14,00

16,00

