

www.cela.it





25,00 m



14,00 m



260 kg

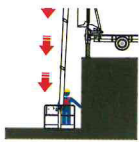

-5,00 m



230 kg

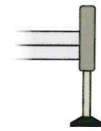

H+H



23,00 m

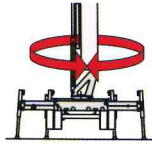

1440°

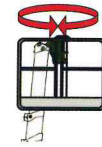

90°+90°

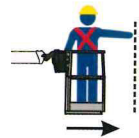

12,00 m

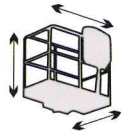

ALUMINIUM
0,7X0,7X1,1
1,4X0,7X1,1
1,8X0,7X1,1



ELECTRONIC

DT25

MIN. PTT 3,5 T

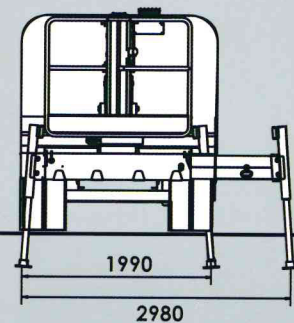
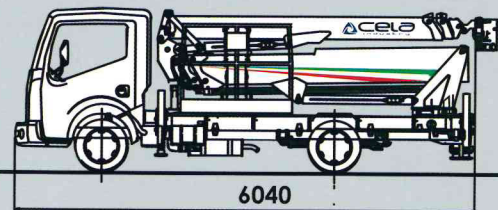
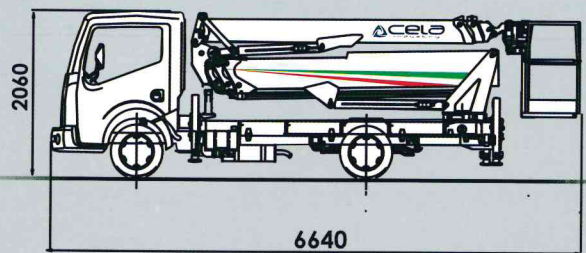
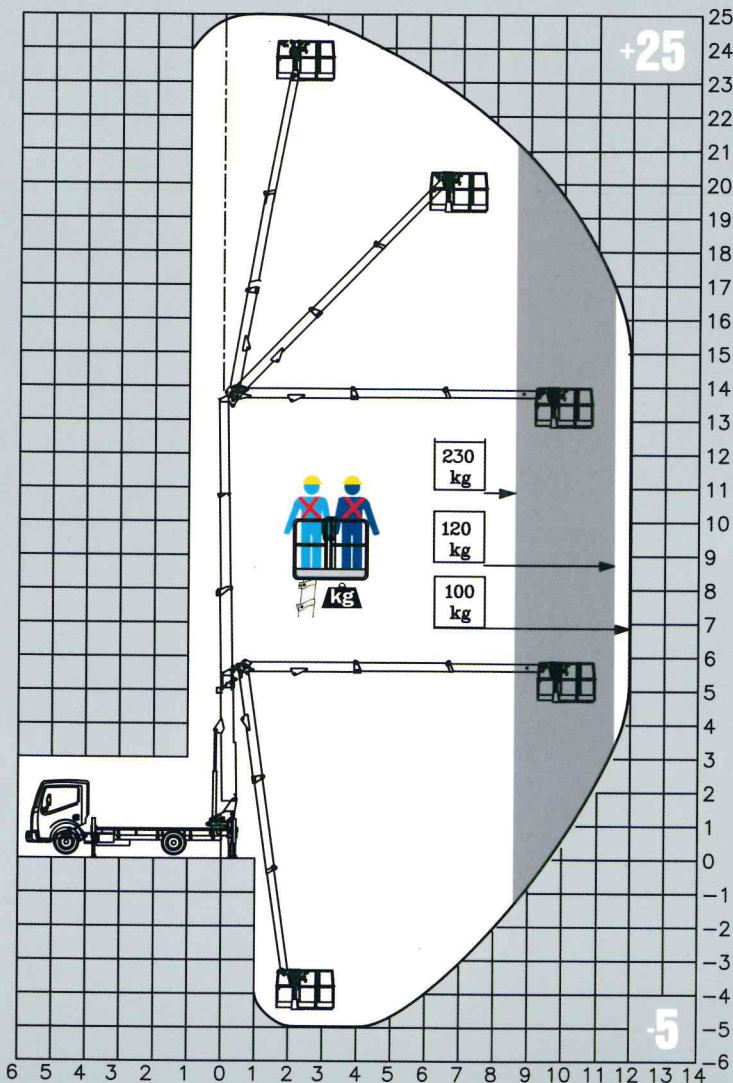

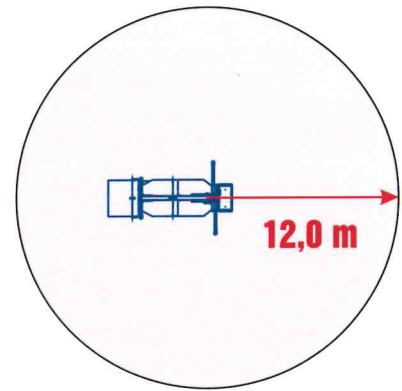
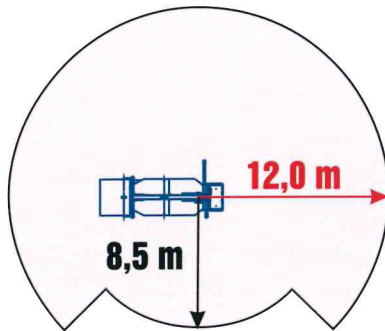
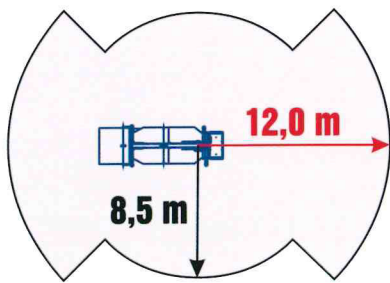

La piattaforma invisibile
The invisible boom



Passiamo sopra ogni cosa
We fly all over

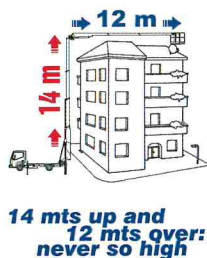

**14 mts up and
12 mts over:
never so high**

Sottosopra
Downunder



Tutto in uno
All in one



Atterriamo ovunque
We land everywhere

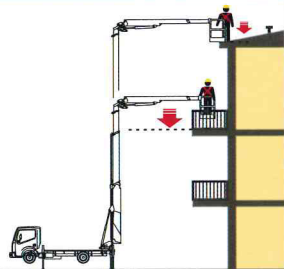

Come un ascensore
Like an elevator



14 m

Dolci e Veloci
Smooth and fast

**Comandi a controllo elettronico,
manovre multiple simultanee**
Electronic controls, multi syncro manoeuvres

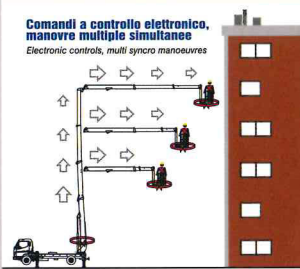

Auto Stabilizzazione
Automatic Stabilization

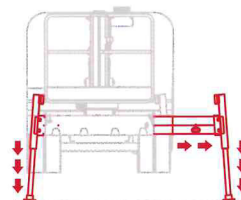

Non ti facciamo girare la testa
We don't drive (your head) crazy

90° + 90°

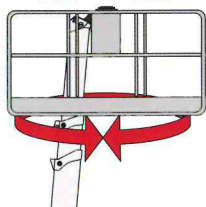

Siamo i più forti
We are the strongest ones

230 kg



260 kg



Portata Utile - Capacity

Sempre al tuo fianco
Always with you



Ti spianiamo la strada
We pave your road

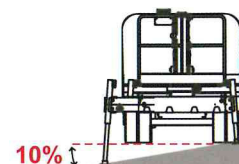

12,00

25,00

14,00

DT25

